

## GMS 10.3 Tutorial

# Stratigraphy Modeling—Horizons and Solids

Create solids from boreholes using the **Horizons** → **Solids** tool.

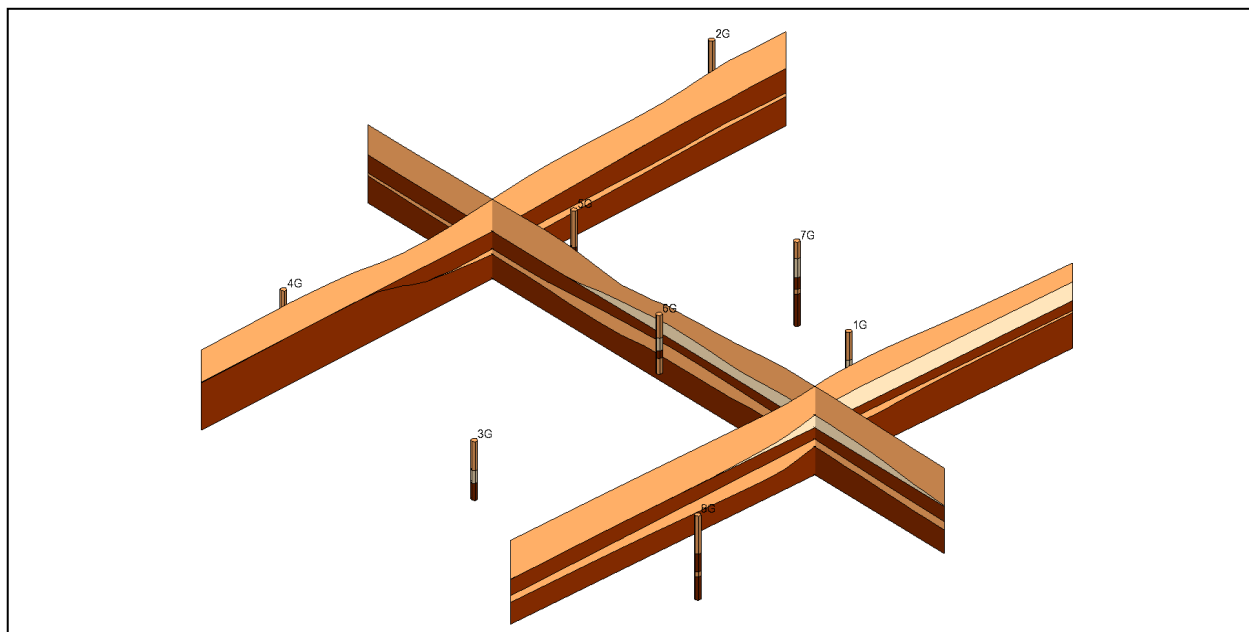

## Objectives

Learn how to construct a set of solid models using the horizon method in GMS. Become familiar with how horizons are numbered and used to create solids. Use borehole cross sections to help control the solid generation process.

### Prerequisite Tutorials

- Feature Objects
- Stratigraphy Modeling—Boreholes and Cross Sections
- Stratigraphy Modeling—TIN Surfaces

### Required Components

- Sub-surface Characterization
- Geostatistics
- Map module

### Time

- 35–45 minutes



<b>1</b>	<b>Introduction</b> .....	<b>2</b>
1.1	Getting Started .....	2
<b>2</b>	<b>Reading Borehole Data</b> .....	<b>3</b>
<b>3</b>	<b>Determining Horizons</b> .....	<b>3</b>
3.1	Horizon IDs.....	4
3.2	Automatically Assigning Horizon IDs.....	4
<b>4</b>	<b>Manually Assigning Horizons</b> .....	<b>6</b>
4.1	Selecting Borehole Contacts .....	6
4.2	Assigning Horizon ID 2 .....	7
4.3	Assigning Horizon ID 3 .....	8
4.4	Assigning Horizon ID 4 .....	9
4.5	Assigning Horizon ID 5 .....	10
4.6	Turning off Horizon IDs.....	11
<b>5</b>	<b>Constructing the TIN</b> .....	<b>12</b>
5.1	Setting up the Coverage .....	12
5.2	Creating the Boundary Polygon .....	13
5.3	Creating a TIN.....	14
<b>6</b>	<b>Creating the Solids</b> .....	<b>14</b>
6.1	Viewing the Solids .....	14
6.2	Cutting Cross Sections .....	15
6.3	Using Borehole Cross Section Data .....	16
6.4	Cutting Cross Sections .....	18
<b>7</b>	<b>Conclusion</b> .....	<b>18</b>

## 1 Introduction

The Solids module of GMS is used to construct three-dimensional models of stratigraphy. Once the solids are created, cross sections can be cut anywhere on the model, the volumes of the solids can be computed, and the solid model can be used to define elevation data for numerical models such as MODFLOW.

This tutorial illustrates how to construct a set of solid models using the horizon method in GMS. A “horizon” refers to the top of each stratigraphic unit represented in the solid. Horizons are defined at borehole contacts: the interface between different materials on a borehole log. Each contact included in the construction of the solid must have a horizon ID. Horizons are numbered consecutively in the order the strata are deposited, from the bottom up. A contact with the default value of zero will be ignored.

Assigning horizon IDs is useful only if a relationship exists between boreholes. Some stratigraphy is so complex that very little, if any, relationship exists between boreholes. In such cases, the approach outlined in the T-PROGS tutorial should be considered.

Creating a solid model of soil stratigraphy using the horizons approach in GMS is quite simple. First, import a set of borehole data. Second, assign horizon IDs to the contacts of the boreholes. Third, create a TIN that can be used to interpolate and define the boundary of the solid. Finally, execute the **Horizons** → **Solids** command to create a set of solids.

### 1.1 Getting Started

1. If necessary, launch GMS.

2. If GMS is already running, select *File / New* to ensure that the program settings are restored to their default state.

## 2 Reading Borehole Data

The first step in the construction of the solid models is to import a set of borehole logs. Borehole data can be entered into GMS manually, or the data can be imported from a file. In the interest of time, the next steps will import a previously prepared file. To import the file, do as follows:

1. Click **Open**  to bring up the *Open* dialog.
2. Browse to the *Tutorials\Stratigraphy\_Modeling\Horizons\_and\_Solids* directory and select “holes.gpr”.
3. Click **Open** to import the logs and close the *Open* dialog.

A 3D view of the borehole logs should appear (Figure 1). Each of the colors represents a different type of soil. They are clean sand, silty sand, and silty-clayey-fine sand.

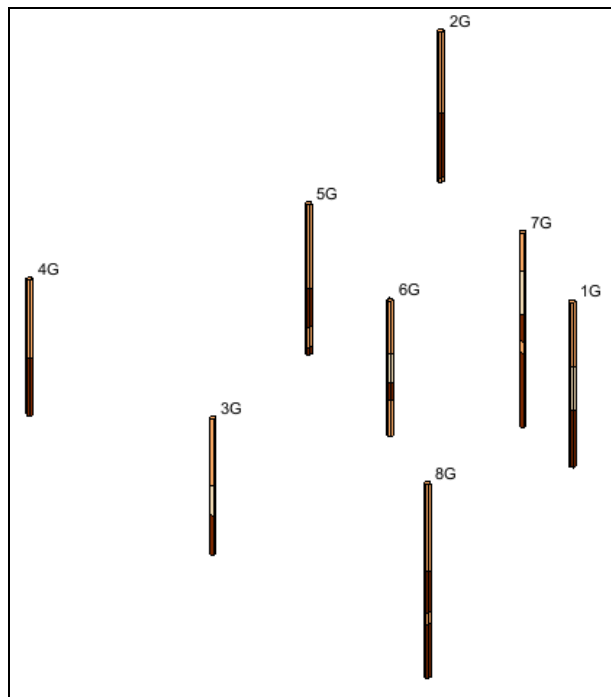

Figure 1 Boreholes

## 3 Determining Horizons

Remember that horizons are numbered consecutively in the order that the strata are deposited, from the bottom up. Horizon IDs are assigned at borehole contacts (the interface between different materials on a borehole log).

1. Look at this set of boreholes and plan how to assign horizon IDs to them.
2. Notice what is common among all the boreholes and what is different.

For example, silty-clayey-fine sand is at the top of every borehole. Also, several boreholes have a clean sand layer on top of a silty sand layer. But some boreholes have more than one silty-clayey-fine sand layer, and some have more than one silty sand layer.

Hole 7G seems to include all the layers that are present on all of the other holes. Therefore, it can be used as a guide to show the order in which the layers were deposited. This tutorial will assign horizon IDs to each contact on hole 7G, starting with 0 at the bottom and ending with 5 at the top. On the other holes, the numbering will have a gap where a layer is missing.

### 3.1 Horizon IDs

---

Next it is necessary to turn on the display of the horizon IDs.

1. Click **Display Options**  to bring up the *Display Options* dialog.
2. Select “Borehole Data” from the list on the left.
3. On the *Borehole* tab in the *Stratigraphy* section, turn on *Horizon IDs*.
4. Click **OK** to close the *Display Options* dialog.

Horizon IDs should now be displayed next to each contact. As the results show, all the horizon IDs are currently at the default value of 0. Zero is a key value that indicates to GMS that it should ignore that horizon when constructing solids.

### 3.2 Automatically Assigning Horizon IDs

---

The next step in the construction of the stratigraphy model is to assign the horizon IDs to the borehole contacts. The easiest way to assign horizon IDs is to let GMS do it automatically.

1. Select *Boreholes* / **Auto-Assign Horizons** to bring up the *Auto-assign Horizons* dialog.
2. Select the *Start from scratch* option and click **Run...** to close the *Auto-assign Horizons* dialog and bring up the *Horizon Optimizer* dialog (Figure 2).

Since only a small number of boreholes exist in this example, the optimizer finishes quickly. With a bigger and more complex set of boreholes, the optimizer can take a significant amount of time.

3. When it finishes, turn on *Read solution on exit* and click **OK** to close the *Horizon Optimizer* dialog.

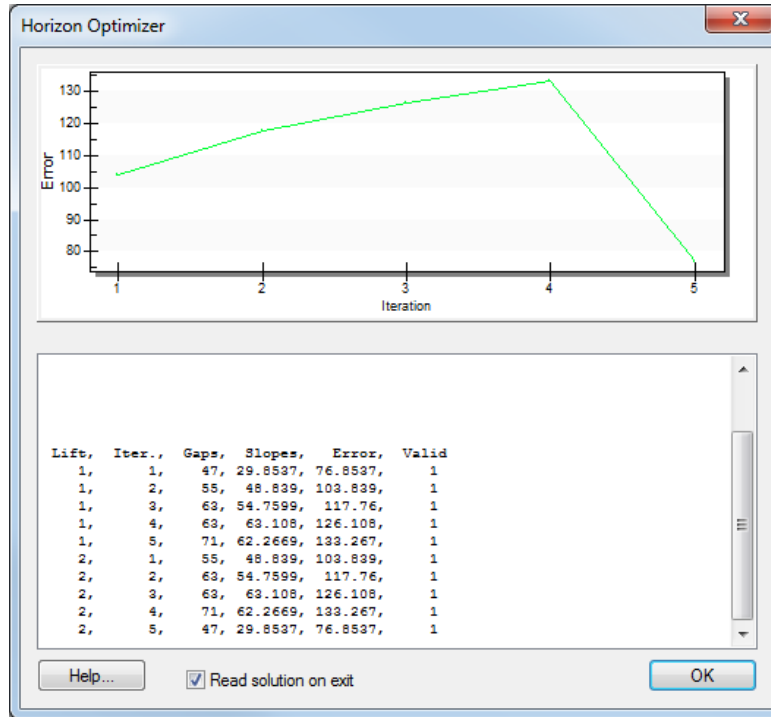

Figure 2 The Horizon Optimizer dialog

The horizon IDs should now be assigned, as seen in the close-up in Figure 3.

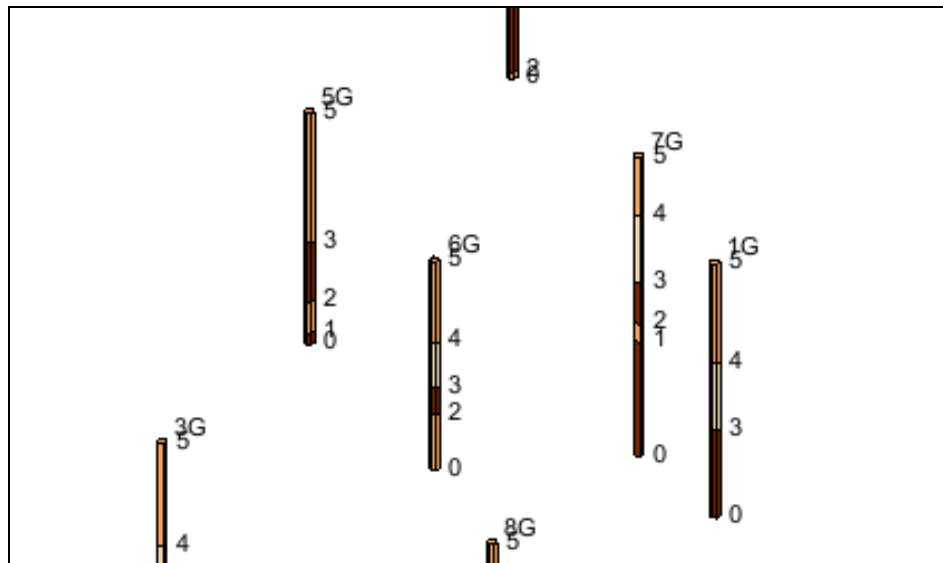

Figure 3 Horizon IDs after automatic assignment

**Note:** The algorithm for automatically assigning horizon IDs is complex and beyond the scope of this tutorial.



The ability to automatically create cross sections and horizon IDs can save a lot of time and effort, especially if working with a large set of complex boreholes. Nevertheless, automatic creation of cross sections and horizon IDs should only be conceptualized as an

initial guess at the real solution. Careful examination of the automatic results is essential, and it is usually necessary to make manual adjustments.

## 4 Manually Assigning Horizons

---



Horizon IDs can also be assigned manually. To do so here, it is first necessary to set all the horizon IDs back to 0.

1. Click on the **Select Contacts**  tool and press *Ctrl-A* (or select *Edit / Select All*) to select all the contacts.
2. Click the **Properties**  macro to bring up the *Contact horizon ID* dialog.
3. Enter “0” for *Horizon ID* and click **OK** to close the *Contact horizon ID* dialog.
4. Click anywhere in the background space of the Graphics Window to unselect the borehole contacts.

### 4.1 Selecting Borehole Contacts

---

Now it is necessary to select a group of borehole contacts and set the horizon IDs. The first horizon to be defined will be the top of the lower silty-clay layer as indicated by arrows in Figure 4.

1. Using the **Select Contacts**  tool, select the top of the lower silty sand material on hole 8G as shown in Figure 4.
2. While holding down the *Shift* key, select the same contact on holes 5G and 7G.
3. Click the **Properties**  macro to bring up the *Contact horizon ID* dialog.
4. Enter “1” for *Horizon ID* and click **OK** to close the *Contact horizon ID* dialog.
5. Click anywhere in the background space of the Graphics Window to unselect the borehole contacts.

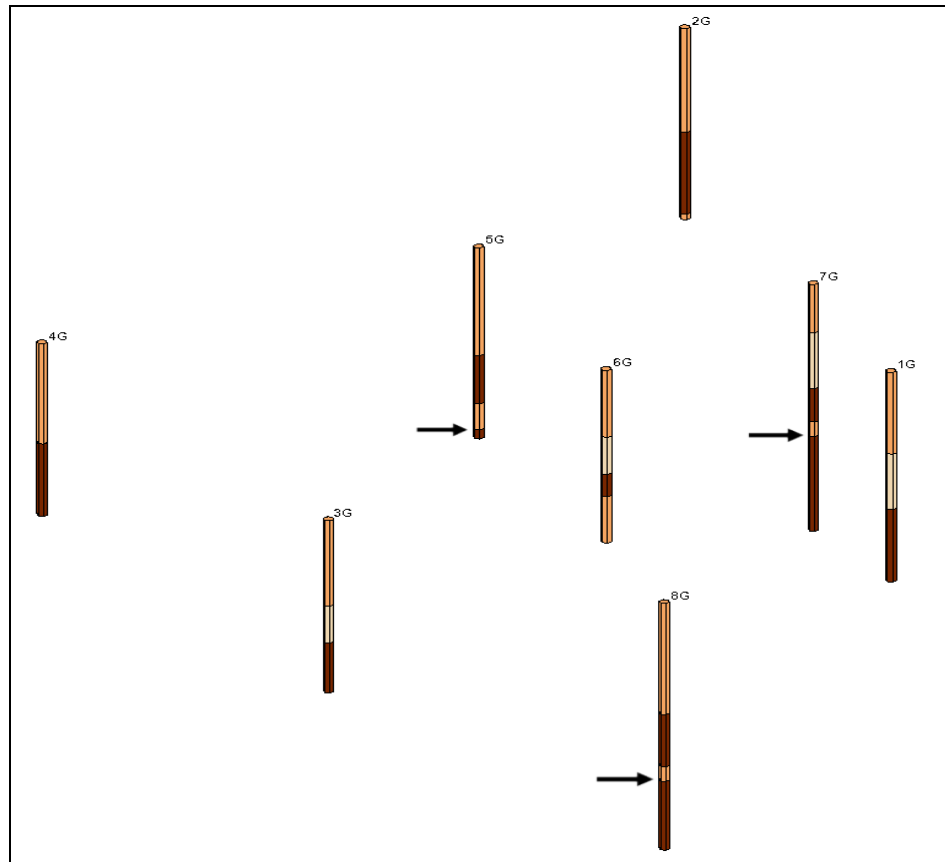



Figure 4 Contacts for Horizon 1

## 4.2 Assigning Horizon ID 2

Next, assign a horizon ID of “2” to the top of the lower silty-clayey-fine sand layer.

6. Using the **Select Contacts**  tool and the *Shift* key, select the borehole contacts shown in Figure 5.
7. Click the **Properties**  macro to bring up the *Contact horizon ID* dialog.
8. Enter “2” for *Horizon ID* and click **OK** to close the *Contact horizon ID* dialog.
9. Click anywhere in the background space of the Graphics Window to unselect the borehole contacts.

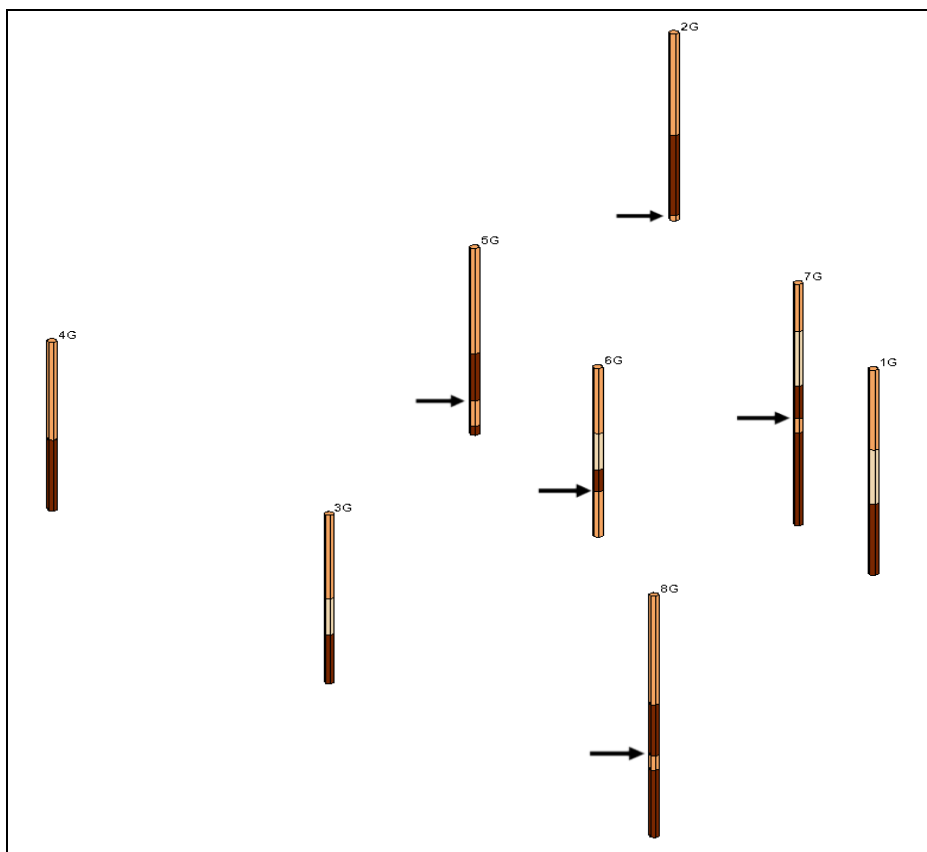



Figure 5 Contacts for Horizon 2

### 4.3 Assigning Horizon ID 3

Horizon ID 3 will be assigned to the top of the upper silty clay layer.

1. Using the **Select Contacts**  tool and the *Shift* key, select the borehole contacts shown in Figure 6.
2. Click **Properties**  to bring up the *Contact horizon ID* dialog.
3. Enter “3” for *Horizon ID* and click **OK** to close the *Contact horizon ID* dialog.
4. Click anywhere in the background space of the Graphics Window to unselect the borehole contacts.



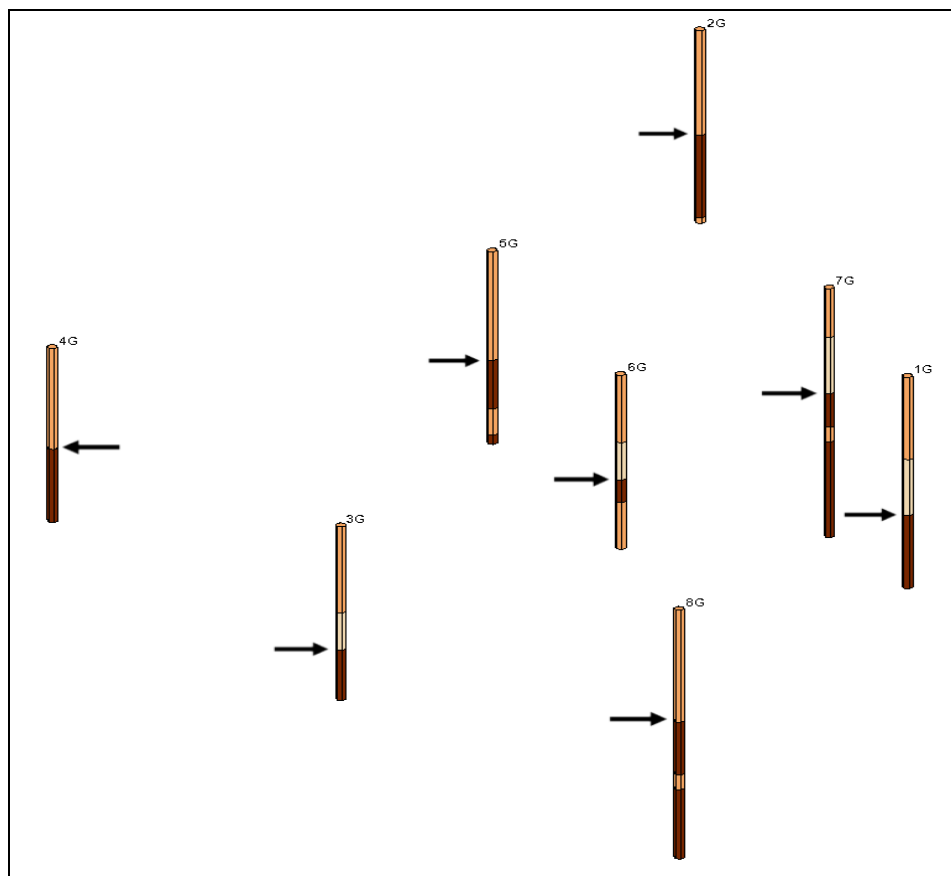



Figure 6 Contacts for Horizon 3

#### 4.4 Assigning Horizon ID 4

The top of the clean sand layer will be assigned horizon ID of 4.

5. Using the **Select Contacts**  tool and the *Shift* key, select all of the contacts at the top of the clean sand material as seen in Figure 7.
6. Click **Properties**  to bring up the *Contact horizon ID* dialog.
7. Enter “4” for *Horizon ID* and click **OK** to close the *Contact horizon ID* dialog.
8. Click anywhere in the background space of the Graphics Window to unselect the borehole contacts.

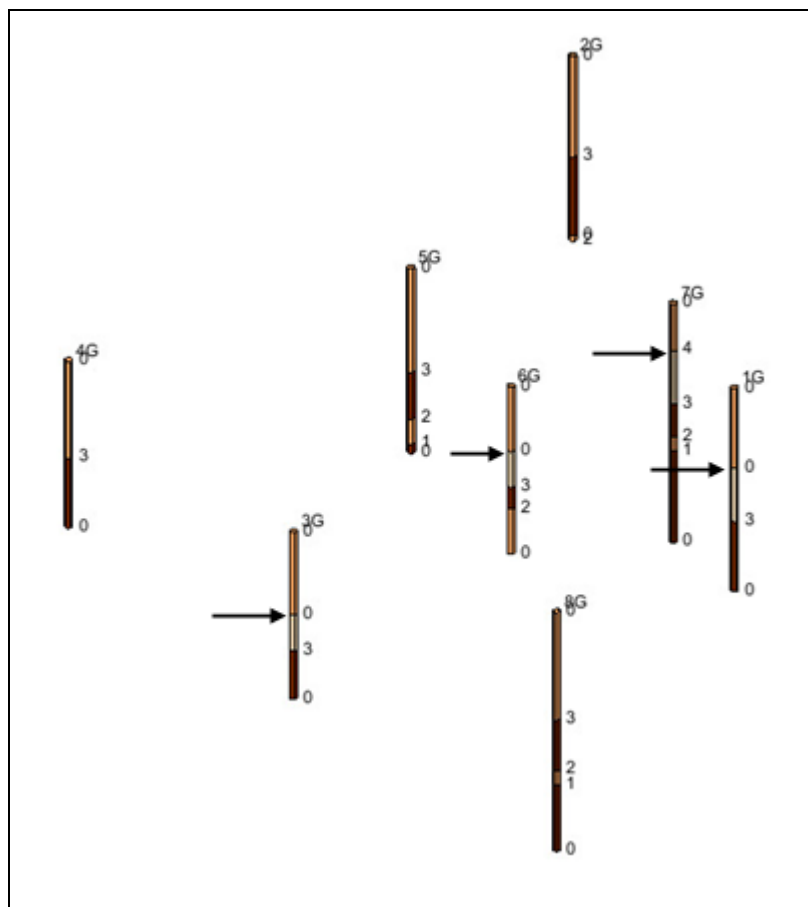



Figure 7 Contacts for Horizon 4

#### 4.5 Assigning Horizon ID 5

The top of the upper silty-clayey-fine sand layer is horizon 5.

1. Using the **Select Contacts**  tool and the Shift key, select the top contact on each borehole as shown in Figure 8.
2. Click **Properties**  to bring up the *Contact horizon ID* dialog.
3. Enter “5” for *Horizon ID* and click **OK** to close the *Contact horizon ID* dialog.
4. Click anywhere in the background space of the Graphics Window to unselect the borehole contacts.

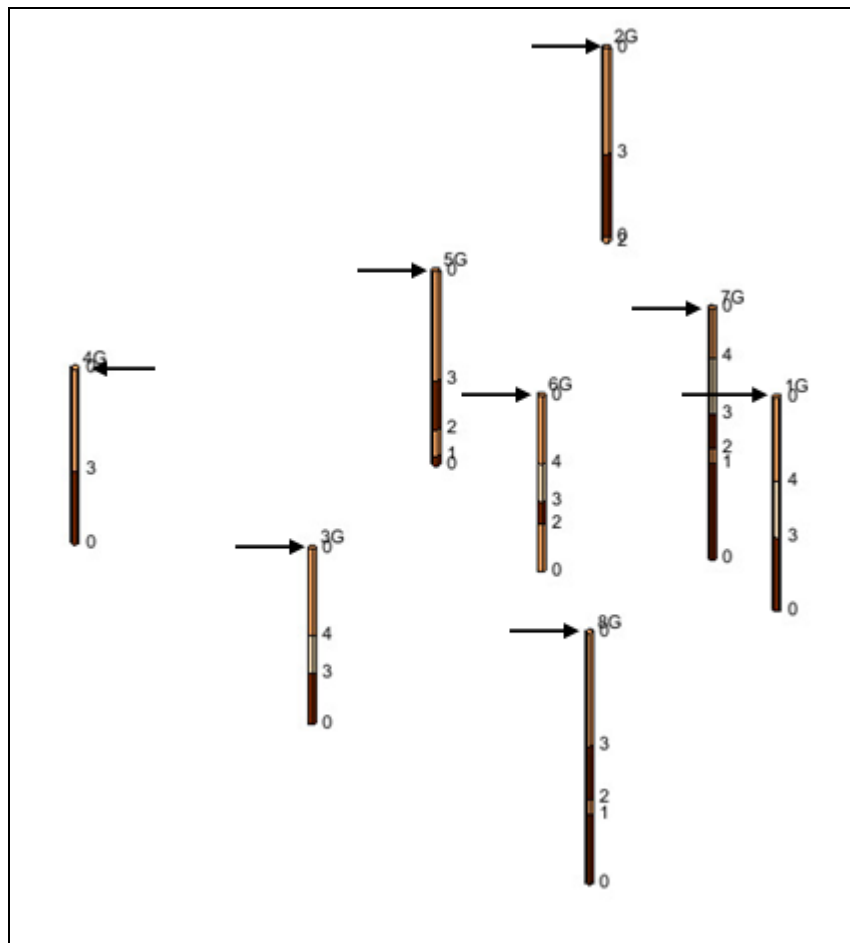



Figure 8 Contacts for Horizon 5

## 4.6 Turning off Horizon IDs

It is beneficial to turn off the display of the horizon IDs so that the display is not cluttered before constructing the TIN in the next section.

1. Click **Display Options**  to bring up the *Display Options* dialog.
2. Select “Borehole Data” from the list on the left.
3. On the *Borehole* tab in the *Stratigraphy* section, turn off *Hole names*.
4. Click **OK** to close the *Display Options* dialog.

The horizon IDs should be assigned as shown in Figure 9.

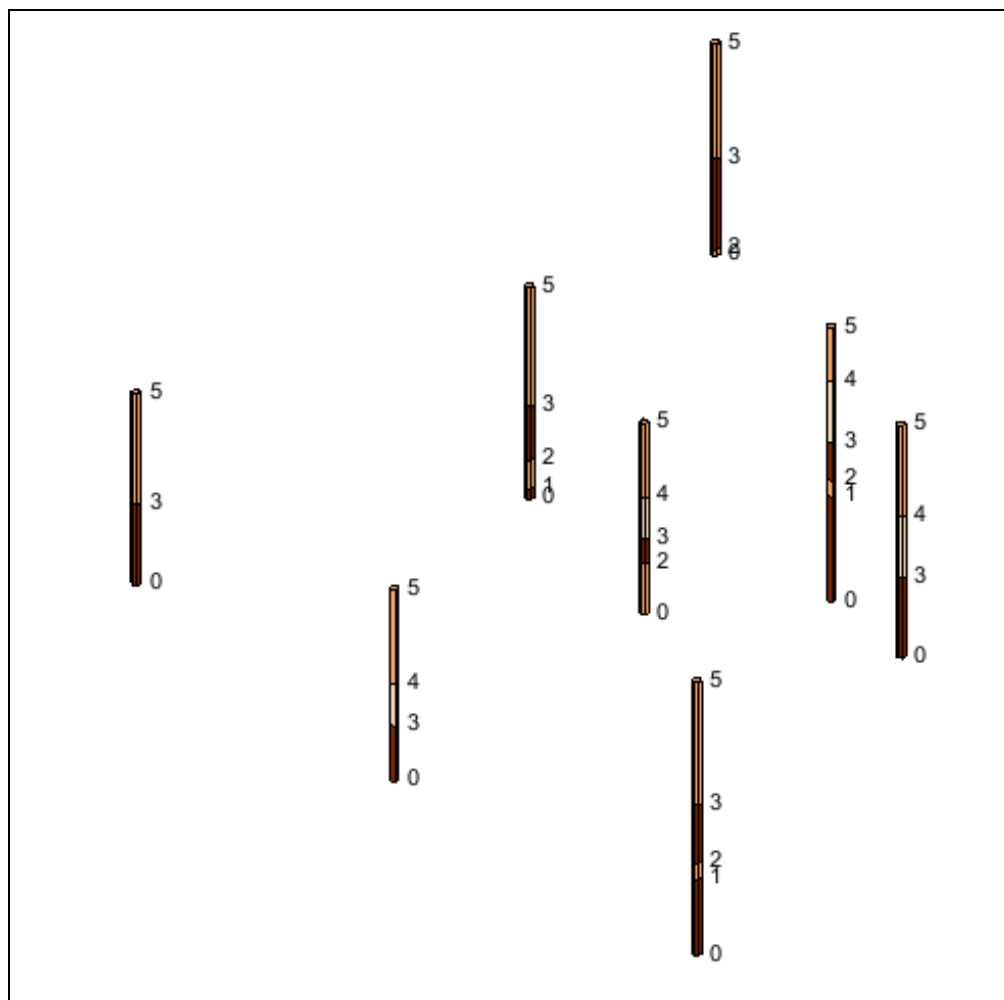

Figure 9 Completed horizon IDs

## 5 Constructing the TIN

It is possible to construct a TIN using the map module in order to define the boundary of the solid. The horizons will also be interpolated to the TIN to define a surface for each horizon. The solid is created by filling in the space between each of the surfaces defined by the interpolation.





### 5.1 Setting up the Coverage

First, define a polygon that will serve as the boundary for the TIN.

1. In the Project Explorer, right-click on the empty space and select *New / Coverage...* to bring up the *Coverage Setup* dialog.
2. Click **OK** to accept the defaults and close the *Coverage Setup* dialog. A new coverage will appear in the Project Explorer.

## 5.2 Creating the Boundary Polygon

To create a polygonal boundary surrounding the boreholes, do the following:

1. Click **Display Options**  to bring up the *Display Options* dialog.
2. Select “Borehole Data” from the list on the left.
3. Turn on *Hole names* and turn off *Horizon IDs*.
4. Click **OK** to close the *Display Options* dialog.
5. Switch to **Plan View** , then click on “ Map Data” in the Project Explorer.
6. Using the **Create Arc**  tool, click out a closed arc surrounding all of the boreholes, as in Figure 10. Click on the starting point to close the polygon.

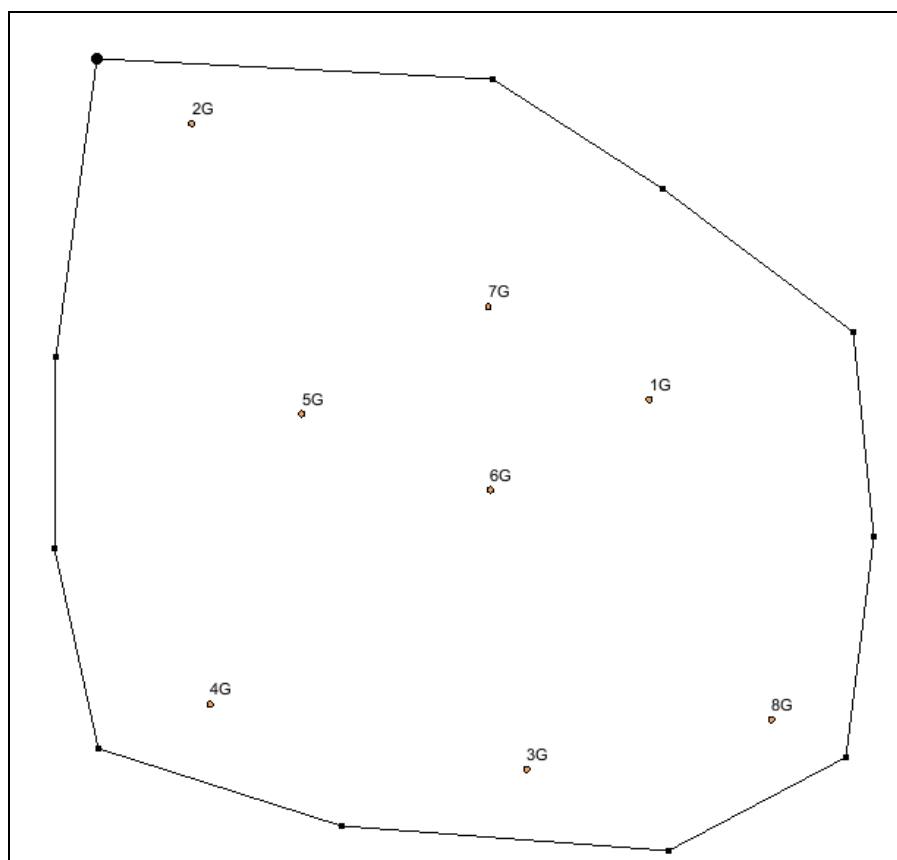



Figure 10 Map polygon surrounding boreholes

7. Select *Feature Objects* / **Build Polygons** to change the closed arc into a polygon.
8. Using the **Select**  tool, select the arc of the newly created polygon, then right-click on it and select **Redistribute Vertices** to bring up the *Redistribute Vertices* dialog.
9. Select “Specified spacing” from the *Specify* drop-down.

10. Enter “50” for the *Average spacing*, and click **OK** to close the *Redistribute Vertices* dialog.

### 5.3 Creating a TIN

---

This polygon will now be used to create a TIN.

1. Select *Feature Objects* | **Map** → **TIN** to bring up the *Properties* dialog.
2. Click **OK** to accept the default TIN properties and close the *Properties* dialog.

A TIN should now appear in the GMS graphics window and in the Project Explorer.

## 6 Creating the Solids

---

Now it is possible to create the solids from the borehole horizons.

1. In the Project Explorer, select the “ Borehole data” folder.
2. Select *Boreholes* | **Horizons** → **Solids** to bring up the *Horizon Elevations* page of the *Horizons to Solids* dialog.

This is where the interpolation scheme used to create the solids is selected. This tutorial will specify how the top and bottom elevation of the stratigraphy model will be determined.



3. Click **Next** to close *Horizon Elevations* page and bring up the *Top and Bottom Elevations* page of the *Horizons to Solids* dialog.
4. In the *Top elevation* section, select *Top of boreholes*. This means that the top of every borehole will be used in interpolating to the top of the solid.
5. In the *Bottom elevation* section, select the *Constant elevation* option and enter a value of “-37”.
6. Click **Next** to close *Top and Bottom Elevations* page and bring up the *Build Solids* page of the *Horizons to Solids* dialog.
7. In the *Interpolation method* section, select *Inverse distance weighted*.
8. Click **Finish** to close the *Horizons to Solids* dialog. After a few moments, a set of solids will appear in the Project Explorer.

### 6.1 Viewing the Solids

---

To view the solids:



1. Switch to **Oblique View**  in order to better see the stratigraphy.

2. Select the “ Solid data” folder in the Project Explorer.
3. Click **Display Options**  to bring up the *Display Options* dialog.
4. Select “Solid Data” from the list on the left.
5. On the *Solid* tab, turn on *Solid faces* and click **OK** to close the *Display Options* dialog.

The result will be a simple solid model consisting of five different layers of materials.

## 6.2 Cutting Cross Sections

To better view the solids, cut some cross-sections:

1. Switch to **Plan View** .
2. Using the **Create Cross-Section**  tool, cut three cross-sections through the solid similar to the ones shown in Figure 11. Single-click to begin making a cross section and double-click to end.

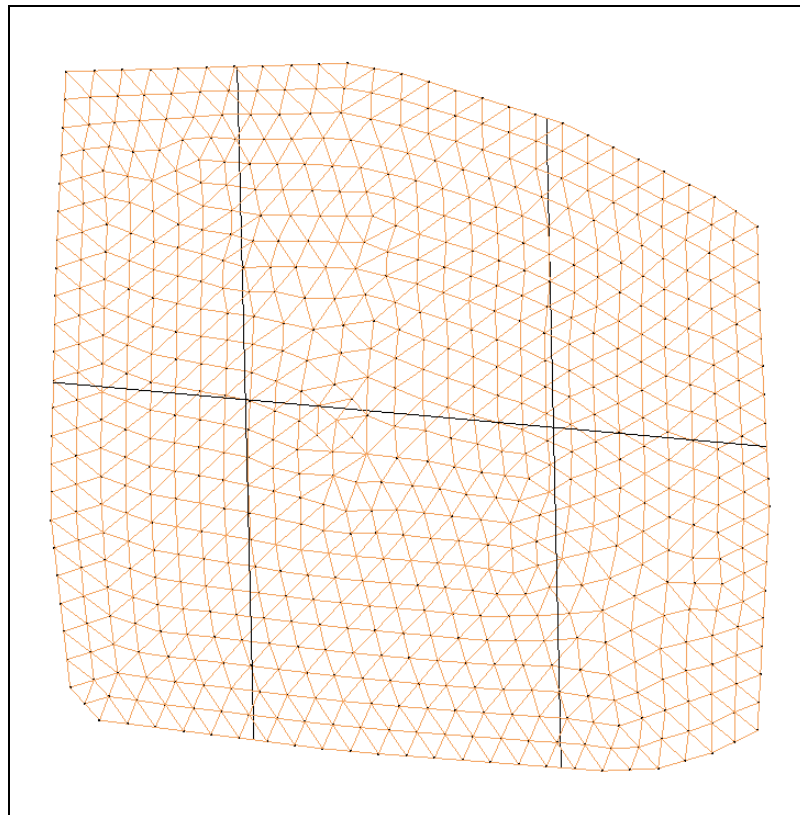







Figure 11 Cross-sections through stratigraphy model

3. In the Project Explorer, expand the “ Solid Data” folder if necessary.

4. Turn off the “solids” subfolder under the “ Solid Data” folder that contains the solids just created.
5. Click **Display Options**  to bring up the *Display Options* dialog.
6. Select “Cross Sections” from the list on the left.
7. On the *Cross Section* tab in the first section, turn on *Cross section faces* and click **OK** to close the *Display Options* dialog.
8. Turn off the “ TIN Data” folder in the Project Explorer.
9. Switch to **Oblique View** .

Now it is possible to see how the different solid surfaces vary (Figure 12).

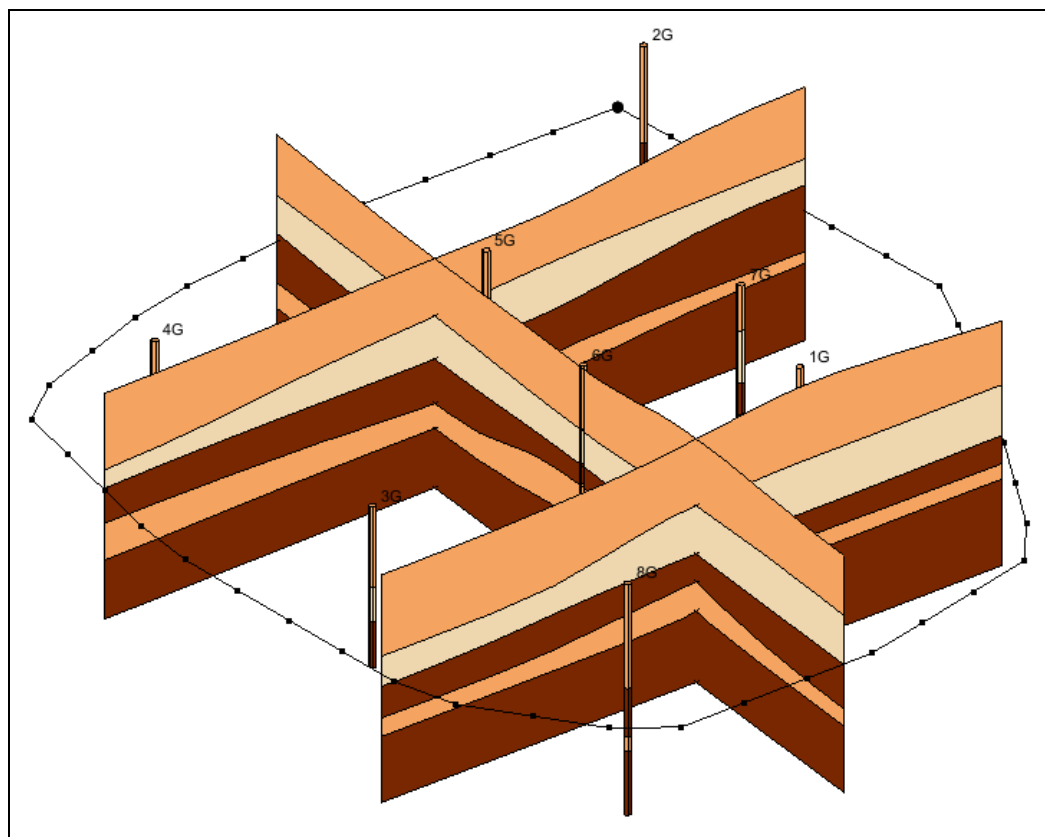

Figure 12 Cross sections in Oblique View



### 6.3 Using Borehole Cross Section Data

The next step is to use borehole cross sections to help guide the creation of the solids. Borehole cross sections are different from cross sections that are cut through solids. They are described in the “Stratigraphy Modeling—Boreholes and Cross Sections” tutorial. If borehole cross sections have been created and the *Use borehole cross section data* option is on in the *Horizons to Solids* dialog, GMS will use the borehole cross sections to help guide the interpolation as it builds the solids.



If cutting cross sections through the resulting solids, the solid cross sections would more closely resemble the borehole cross sections (although they would not match exactly).

To do this, import a previously defined set of cross sections:

1. Click **New**  to clear the current project from GMS. If asked to save the changes, click **Don't Save**.
2. Click **Open**  to bring up the *Open* dialog.
3. Select “Project Files (\*.gpr)” from the *Files of type* drop-down.
4. Browse to the *Tutorials\Stratigraphy\_Modeling\Horizons\_and\_Solids* directory and select “xsects.gpr”.
5. Click **Open** to import the project file and close the *Open* dialog.

It should now be possible to see the cross sections that have been created between the boreholes.

6. Click on the “ Borehole Data” folder in the Project Explorer.
7. Select *Boreholes* | **Horizons** → **Solids** to bring up the *Horizons to Solids* dialog.
8. In the *Boreholes* section, turn on *Use borehole cross sections* and click **Finish** to close the *Horizons to Solids* dialog.

After a few moments, the solids will appear in the Graphics Window and in the Project Explorer (Figure 13).

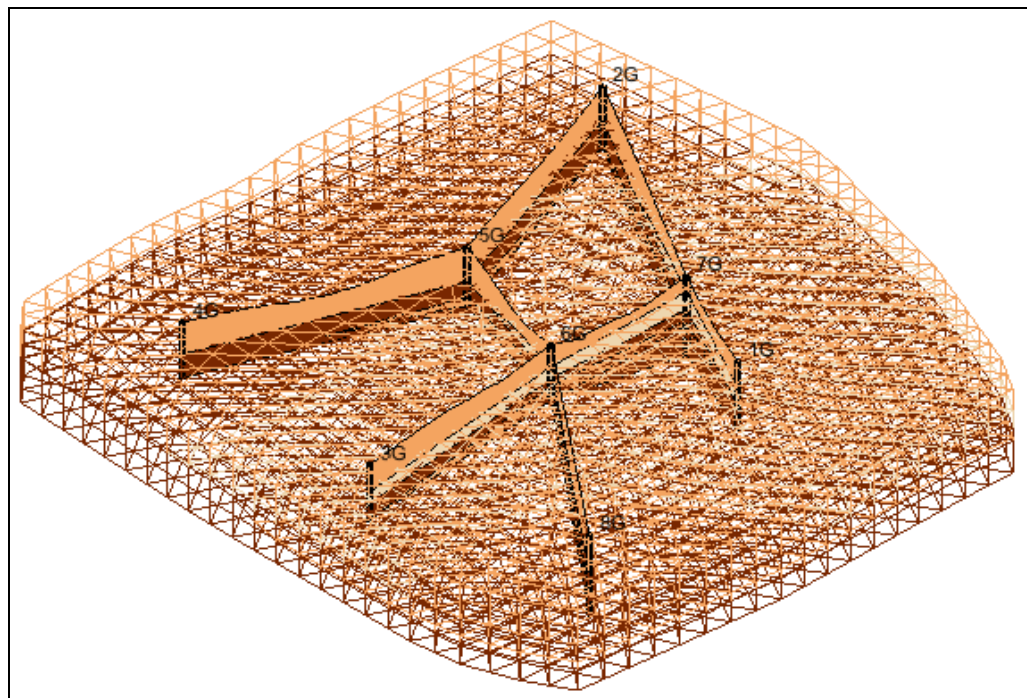





Figure 13 Solids with the borehole cross sections





## 6.4 Cutting Cross Sections

---

The next step is to create cross sections through the solids in the same location as the borehole cross sections. They can be created in any order.

1. Switch to **Plan View**  and select the “ Solid Data” folder.
2. Using the **Create Cross Section**  tool, create solid cross sections in the approximate location where the borehole cross sections are. First, single-click on hole 1G, then single-click on holes 7G, 2G, 5G, and 6G, and then finish by double-clicking on hole 8G.
3. Create another cross section between holes 3G, 6G, and 7G.
4. Create the final cross section between holes 4G and 5G.

To view the newly created solid cross sections, do the following:

5. In the Project Explorer under the “ Borehole Data” folder, turn off the “ Cross Sections” folder to hide all of the solids.
6. In the Project Explorer under the “ Solid Data” folder, uncheck the box next to the “ solids” folder to hide all of the solids.
7. Switch to **Oblique View** .

The cross sections created from the solids should now be visible. The solid cross sections should look very similar to the borehole cross sections. Feel free to turn the “Cross Sections” folder on and off to see the difference between the two sets of cross sections.

## 7 Conclusion

---

This concludes the “Stratigraphy Modeling – Horizons and Solids” tutorial. The following key topics were discussed and demonstrated:

- Solids can be created directly from boreholes if horizon numbers are assigned to the borehole contacts.
- If the borehole data is too complex, use the T-PROGS approach rather than create cross sections and assign horizon IDs.
- Horizons are numbered consecutively in the order that the strata are deposited, from the bottom up.
- Horizon IDs can be automatically assigned to all boreholes, but it will take a long time for a large, complex set of boreholes.
- Solids can be created from horizons.
- Borehole cross sections can be used to further control the **Horizons** → **Solids** process.