

GMS 10.3 Tutorial

SEEP2D – Earth Dam

Use SEEP2D to compute seepage through an earth dam

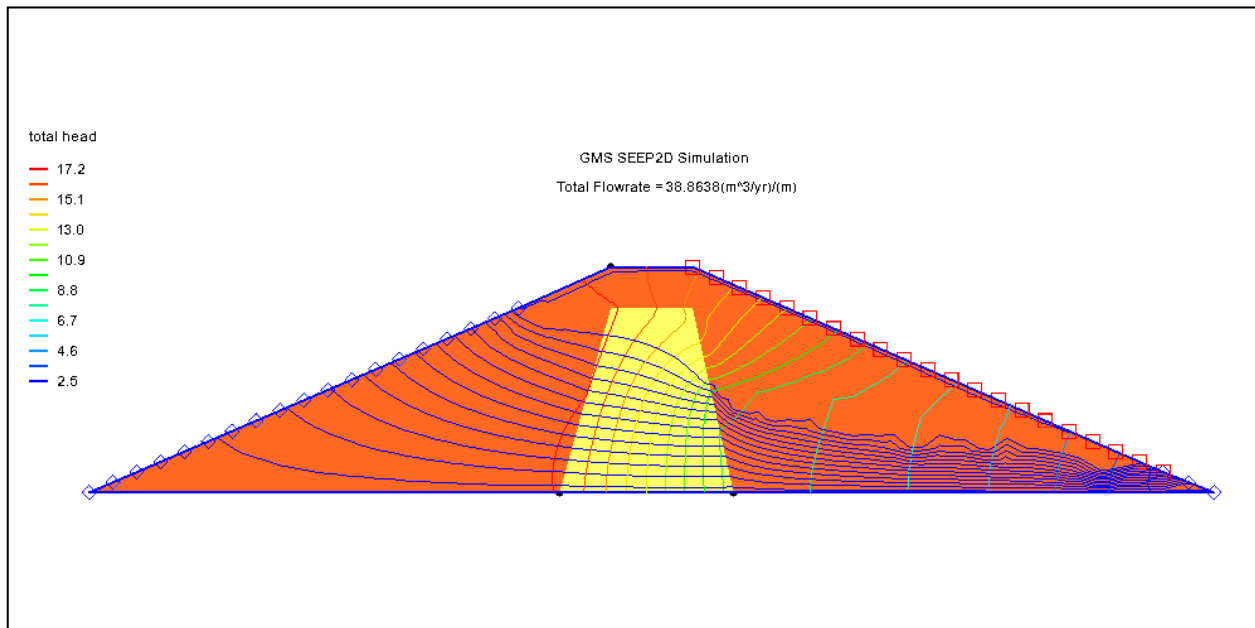

Objectives

This tutorial will show how to use the SEEP2D interface in GMS to compute seepage through an earth dam. The tutorial will use different material properties for the shell and core of the dam. It will also use the exit-face boundary condition on the downstream slope.

Prerequisite Tutorials

- Feature Objects

Required Components

- GIS
- Map Module
- Mesh Module
- SEEP2D

Time

- 25–40 minutes



1	Introduction	2
2	Setup	3
2.1	Program Mode.....	3
2.2	Getting Started	3
2.3	Setting the Units	4
2.4	Saving the Project	4
3	Creating the Conceptual Model Features	5
3.1	Defining a Coordinate System.....	5
3.2	Creating the Corner Points	5
3.3	Creating the Arcs.....	6
3.4	Creating the Polygons	6
3.5	Assigning the Material Properties and Zones	7
4	Assigning Boundary Conditions	8
4.1	Specified-Head Boundary Conditions	8
4.2	Exit-Face Boundary Conditions	9
4.3	Building the Finite Element Mesh.....	9
5	Setting the Analysis Options	11
6	Running SEEP2D	12
7	Viewing the Solution	12
8	Conclusion	13

1 Introduction

This tutorial describes the steps involved in performing a SEEP2D simulation for an earth dam with an unsaturated zone.

The problem in this tutorial is shown in Figure 1. The problem consists of an earth dam with anisotropic soil and a low permeability core in the interior.

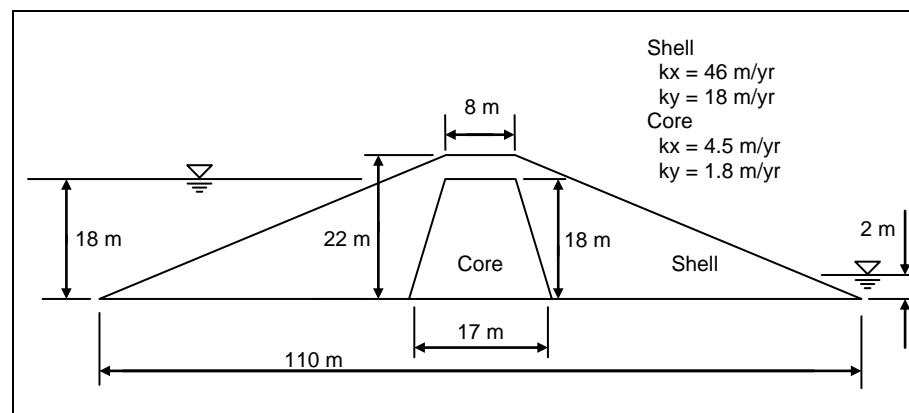

Figure 1 Earth dam problem

This tutorial will discuss and demonstrate creating a SEEP2D conceptual model, mapping the model to a 2D mesh, defining conditions for both a saturated and unsaturated zone, converting the model to SEEP2D, and running SEEP2D.

2 Setup

2.1 Program Mode

The GMS interface can be modified by selecting a *Program Mode*. When GMS is first installed and runs, it is in the standard or “GMS” mode, which provides access to the complete GMS interface, including all of the MODFLOW tools. The “GMS 2D” mode provides a greatly simplified interface to the SEEP2D and UTEXAS codes. This mode hides all of the tools and menu commands not related to SEEP2D and UTEXAS. This tutorial can only be completed in the GMS 2D mode.

Once the mode is changed, GMS can be exited and restarted repeatedly and the interface stays in the same mode until changed. Thus, it’s only necessary to change the mode once if intending to repeatedly solve SEEP2D/UTEXAS problems. If already in GMS 2D mode, skip ahead to the Getting Started section. If not already in GMS 2D mode, do the following:

1. Launch GMS.
2. Select *Edit / Preferences...* to bring up the *Preferences* dialog.
3. Select “Program Mode” from the list on the left.
4. Select “GMS 2D” from the *Program Mode* drop-down.
5. Click **OK** to close the *Preferences* dialog.
6. Click **Yes** in response to the warning about all data being deleted. After a moment, the *New Project* dialog will appear.
7. Click **OK** to close the *New Project* dialog.
8. Select *File / Exit* to exit GMS.

2.2 Getting Started

Do the following to get started:

1. If necessary, launch GMS.
2. If GMS is already running, select *File / New* to ensure that the program settings are restored to their default state.

The *New Project* dialog will appear. This dialog is used to set up a GMS conceptual model. A conceptual model is organized into a set of layers or groups called “coverages”. GMS 2D allows quickly and easily defining all of the coverages needed for the conceptual model using the *New Project* dialog. Most of the options seen in the window are related to UTEXAS. For SEEP2D models, the only coverage needed is the *Profile lines* coverage. This allows defining the geometry of the mesh, the boundary conditions, and the material zones.

3. Select *Create a new project* and enter “Earth Dam Model” as the *Conceptual model name*.
4. In the *Numerical models* section, turn off *UTEXAS*.
5. In the *Create coverages* section, select only *Profile lines*.
6. Click **OK** to close the *New Project* dialog.

A new “Earth Dam Model” conceptual model object should appear in the Project Explorer.

2.3 Setting the Units

Before continuing, it is necessary to establish the units to be used. GMS will display the appropriate units label next to each of the input fields as a reminder to be consistent.

1. Select *Edit | Units...* to open the *Units* dialog.
2. Click the  button to the right of *Length* to bring up the *Display Projection* dialog.
3. In both the *Horizontal* and *Vertical* sections, select “Meters” from the *Units* drop-down.
4. Click **OK** to close the *Display Projection* dialog
5. Select “yr” from the *Time* drop-down.
6. Select “kg” from the *Mass* drop-down.
7. Select “N” from the *Force* drop-down.
8. Click **OK** to close the *Units* dialog.

2.4 Saving the Project

Before continuing, save the project to a GMS project file.

1. Select *File | Save As...* to bring up the *Save As* dialog.
2. Browse to the *\Tutorials\SEEP2D* directory.
3. Select “Project Files (*.grp)” from the *Save as type* drop-down.
4. Enter “s2uncon.grp” as the *File name*.
5. Click **Save** to create the project file and close the *Save As* dialog.

It is recommended to use the **Save**  macro frequently while working on any project.

3 Creating the Conceptual Model Features

The first step in setting up the problem is to create the GIS features defining the problem geometry. This process starts with entering a set of points corresponding to the key locations in the geometry. Then connect the points with lines called “arcs” to define the outline of the problem. Next, convert the arcs to a closed polygon defining the problem domain. Once this is complete, the arcs and the polygon will be used to build the finite element mesh and define the boundary conditions to the problem.

3.1 Defining a Coordinate System

Before constructing the conceptual model features, first establish a coordinate system. Use a coordinate system with the origin at the lower left corner of the dam as shown in Figure 2.

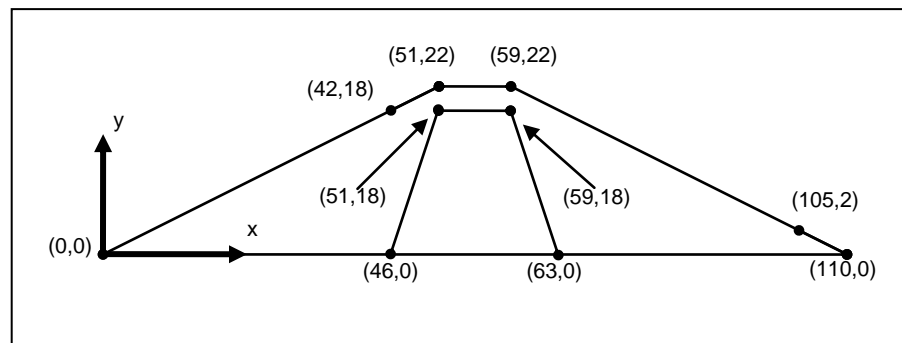



Figure 2 Coordinate system

3.2 Creating the Corner Points

Now create some points at key corner locations. These points will then be used to guide the construction of a set of arcs defining the model boundary. If desired, create points one at a time using the **Create Points** tool, but it is usually easier to enter the point coordinates in a spreadsheet.

1. Right-click on the “Profile lines” coverage in the Project Explorer and select **Attribute Table...** to open the *Attribute Table* dialog.
2. Enter the coordinates as in the spreadsheet to the right.
3. Click **OK** to exit the dialog.
4. Click **Display Options** to bring up the *Display Options* dialog.
5. Select “Map Data” from the list on the left.
6. Turn on *Labels* to the right of *Points*.

Point Name	X	Y
A	0	0
B	42	18
C	51	22
D	59	22
E	51	18
F	59	18
G	46	0
H	63	0
I	105	2
J	110	0

7. Click **OK** to close the *Display Options* dialog.
8. Click **Frame Image**  to center the view on the new points (Figure 3).

The node coordinates can be edited using the **Select Points/Nodes**  tool. Select the desired point and change the coordinates using the XYZ edit fields at the top of the Graphics Window. Points can be deleted by selecting them and pressing the *Delete* key on the keyboard (or selecting *Edit | Delete*).

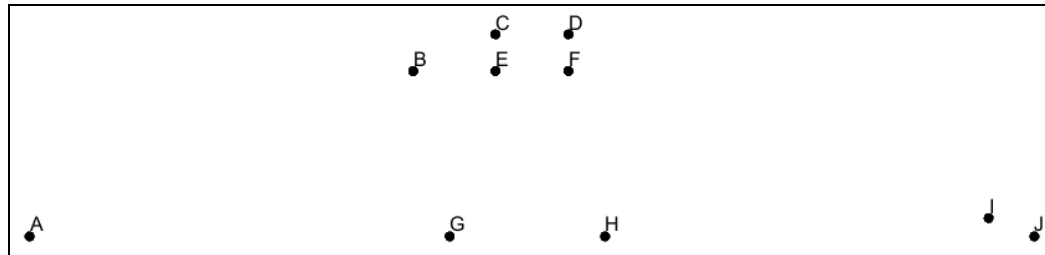



Figure 3 Points created in the profile lines coverage

3.3 Creating the Arcs

Now that the corner nodes are created, create the arcs defining the boundaries of both the shell and the core of the dam. This can be accomplished as follows:

1. Click on the “Profile lines” coverage to make it active.
2. Using the **Create Arc**  tool, create a connected series of arcs around the perimeter of the dam by clicking on the following points in order: A–B–C–D–I–J–H–G–A. As the points are changed to nodes (with the creation of the arcs), the label for each point will disappear.
3. Create the remaining arcs around the core boundary by clicking on the following points in order: G–E–F–H. The arc between H and G was created in step 2, and therefore does not need to be created again.

3.4 Creating the Polygons

Now that the arcs are created, use the arcs to build polygons representing the regions enclosed by the arcs. Then use the polygons to assign the material zones. To build the polygon, do the following:

1. Select *Feature Objects | Build Polygons*.

The polygons will have a gray background (Figure 4).

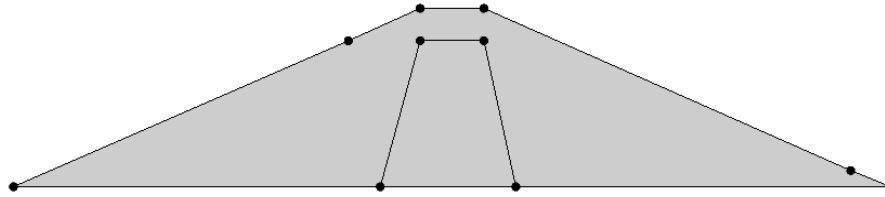



Figure 4 Polygons with a gray background

3.5 Assigning the Material Properties and Zones

Next, assign the material properties and zones. Start by creating a material for each of the two zones in the problem and giving each material a unique name, color, and set of hydraulic properties.

1. Click **Materials**  to bring up the *Materials* dialog.
2. On the *SEEP2D* tab, notice that there is already one material. Use this material to represent the shell and create a new material for the core.
3. Rename “material_1” to “Shell” in the *Name* column of the spreadsheet.
4. In the *Color/Pattern* column in row 1, click the down arrow to the right of the wide color button and select “light orange” from the list of swatches.
5. On row 1:
 - Enter “46” in the *k1* column.
 - Enter “18” in the *k2* column.
 - Enter “-0.3” in the *Sat/Unsat linear front ho* column.
 - Enter “0.001” in the *Sat Unsat linear front kro* column.
6. Create a new material by entering “Core” in the *Name* column of the blank row (marked with a “*”) at the bottom of the spreadsheet. The row is now numbered “2”.
7. In the *Color/Pattern* column in row 2, select “pale green” from the list of swatches.
8. On row 2:
 - Enter “4.6” in the *k1* column.
 - Enter “1.8” in the *k2* column.
 - Enter “-1.2” in the *Sat/Unsat linear front ho* column.
 - Enter “0.001” in the *Sat Unsat linear front kro* column.
9. Click **OK** to close the *Materials* dialog.

Note that both polygons are currently associated with the “Shell” material (Figure 5). Change the material assigned to the core polygon to the new “Core” material.

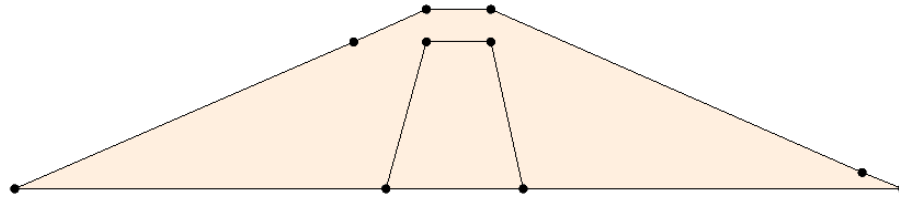



Figure 5 Both polygons are the same material

10. Using the **Select Polygons**  tool, double-click inside the core polygon to bring up the *Attribute Table* dialog.
11. In the *Material* column of the spreadsheet, select “Core” from the drop-down.
12. Click **OK** to close the *Attribute Table* dialog.
13. Click anywhere outside the polygons in the *Graphics Window* to unselect the polygon.

The Core is now colored to reflect the materials assignment (Figure 6).

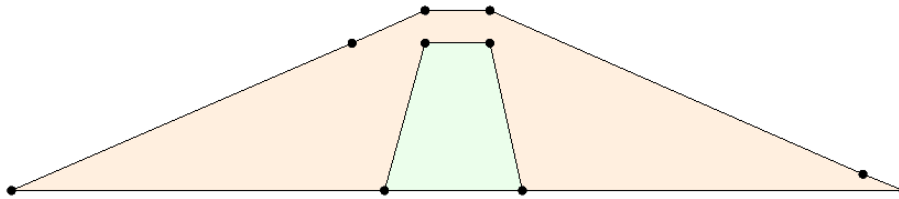



Figure 6 Showing the different material assignments

4 Assigning Boundary Conditions

The next step in defining the model is to assign boundary conditions to the conceptual model. For the problem being modeled, there are three types of boundary conditions: no-flow boundary (flow is parallel to the boundary), specified-head boundary, and exit-face boundary. Boundaries without an explicit condition are no-flow by default. This type is not covered in detail in this tutorial.

4.1 Specified-Head Boundary Conditions

To enter the specified-head boundary conditions, do the following:

1. Using the **Select Arcs**  tool, double-click on the A–B arc on the left side (Figure 7) to bring up the *Attribute Table* dialog.
2. In the *Type* column in the spreadsheet, select “head” from the drop-down.
3. Enter “18.0” in the *Head (m)* column.

4. Click **OK** to close the *Attribute Table* dialog.
5. Repeat steps 1–4 with the I–J arc on the lower right side (Figure 7), entering “2.0” in the *Head (m)* column.
6. Click anywhere outside of the polygons to unselect the arc.

The arcs will now be blue, indicating they have specified-head boundary conditions (Figure 7).

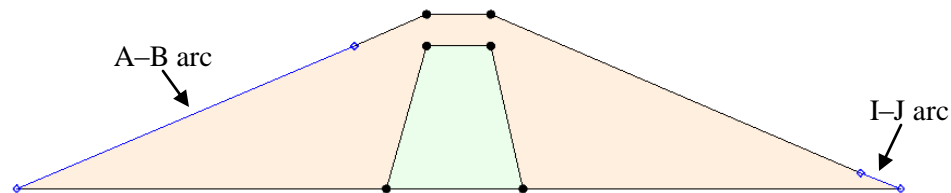



Figure 7 Specified-head boundaries

4.2 Exit-Face Boundary Conditions

The remaining boundary condition is an exit face. Since the project is modeling an unconfined condition, SEEP2D will iterate to find the location of the phreatic surface. To guide the iteration process, mark all of the nodes on the mesh where the phreatic surface may exit as exit-face nodes.

Do the following to define the exit-face boundary conditions:

7. Using the **Select Arcs**  tool, double-click on the D–I arc on the upper right (Figure 8) to bring up the *Attribute Table* dialog.
 1. In the *Type* column in the spreadsheet, select “exit face” from the drop-down.
 2. Click **OK** to exit the *Attribute Table* dialog.
 3. Click anywhere outside the polygons to unselect the arc.

The arc will now be red, indicating it has an exit face boundary condition (Figure 8).

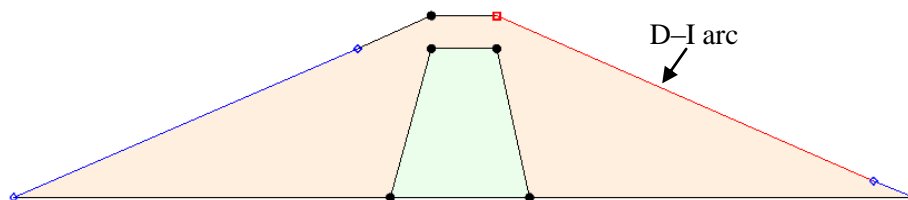



Figure 8 Exit-face boundary

4.3 Building the Finite Element Mesh

It is now possible to build the finite element mesh used by SEEP2D. The mesh is automatically constructed from arcs and polygons in the conceptual model. The arcs are

composed of both nodes and vertices. The nodes are the two end points of the arc. The vertices are intermediate points between the nodes. The gaps between vertices are called edges.

At this point, all of the arcs have one edge and zero vertices. When mapping to a 2D mesh, the density of the elements in the interior of the mesh is controlled by the edge spacing along the arcs. Thus, subdivide the arcs to create appropriately sized edges.

4. Using the **Select Arcs**  tool, select all of the arcs by dragging a box that encloses all of the arcs.
1. Select *Feature Objects* / **Redistribute Vertices...** to bring up the *Redistribute Vertices* dialog.
2. Select “Specified spacing” from the *Specify* drop-down.
3. Enter “2.5” for the *Average spacing*.
4. Click **OK** to close the *Redistribute Vertices* dialog.
5. Switch to the **Select Vertices**  tool.

Notice the vertex spacing (Figure 9). The vertices are turned off by default but become visible when the **Select Vertices**  tool is active.

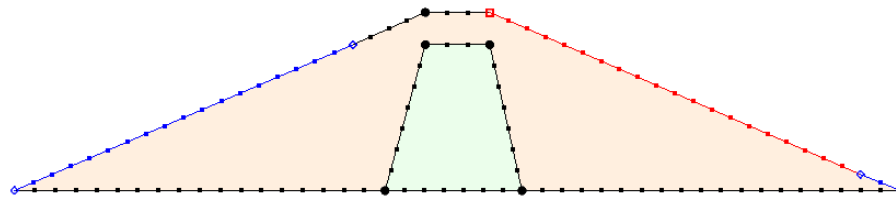



Figure 9 Evenly-spaced vertices

To make the vertices always visible, do the following:

6. Click **Display Options**  to bring up the *Display Options* dialog.
7. Select “Map Data” from the list on the left.
8. On the *Map* tab, turn on *Vertices* and click **OK** to close the *Display Options* dialog.

In this particular problem, most of the head loss will occur in the core of the dam. To more accurately model the core, make the mesh denser in the core of the dam.

9. Using the **Select Arcs**  tool, hold down the *Shift* key and select the arcs that make up the core of the dam (G–E, E–F, F–H, H–G).
10. Select *Feature Objects* / **Redistribute Vertices...** to bring up the *Redistribute Vertices* dialog.
11. Select “Specified spacing” from the *Specify* drop-down.
12. Enter “1.0” for the *Average spacing*.

13. Click **OK** to close the *Redistribute Vertices* dialog.

At this point, it is possible to construct the mesh.

14. Click the **Map** → **2D Mesh**  macro at the top of the GMS window (or select *Feature Objects* / **Map** → **2D Mesh**) to create the 2D mesh (Figure 10).

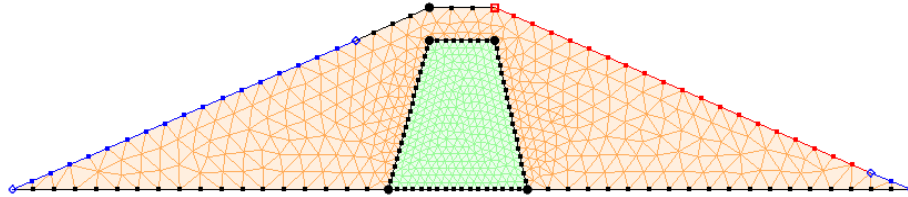



Figure 10 The 2D mesh has been created

Finally, convert the conceptual model to the SEEP2D numerical model. This will assign all of the boundary conditions defined on the feature objects to the node-based boundary conditions required by SEEP2D.

15. Click the **Map** → **SEEP2D**  macro at the top of the GMS window (or select *Feature Objects* / **Map** → **SEEP2D**).

A set of blue and red symbols should appear indicating that the boundary conditions have been assigned (Figure 11).

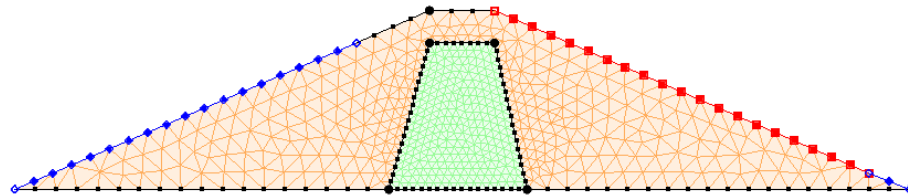



Figure 11 SEEP2D boundary conditions assigned

5 Setting the Analysis Options

Before running the model, adjust the analysis options.

1. Save the model by clicking the **Save**  macro.
2. Select *SEEP2D* / **Analysis Options...** to open the *SEEP2D Analysis Options* dialog.
3. Enter “9810.0” as the *Unit weight of water*. The current units are N/m³.



Two methods are provided in SEEP2D for computing the relative conductivity in the unsaturated zone: the linear front method and the Van Genuchten method. With the linear front method, the relative conductivity varies linearly from the saturated value down to a user-specified minimum at a given negative pressure head. With the Van Genuchten method, the Van Genuchten parameters are used to define the variation of the

relative conductivity in the unsaturated zone. Both methods are described in detail in the “SEEP2D Primer”. For this tutorial, use the linear front option.

4. In the *Model type* section, select *Saturated/Unsaturated with linear front*.
5. Click **OK** to exit the *SEEP2D Analysis Options* dialog.

6 Running SEEP2D

It is now possible to run SEEP2D. Before running SEEP2D, make sure all of the changes have been saved to disk:

1. Click **Save** .
2. Click the **Run SEEP2D**  macro (or select *SEEP2D | Run SEEP2D*) to bring up the *SEEP2D* model wrapper dialog.
3. When the solution is finished, turn on *Read solution on exit* and click **Close** to close the *SEEP2D* model wrapper dialog.

GMS will automatically import the SEEP2D solution when this dialog is closed. A set of contour lines will also appear on the model of the dam (Figure 12).

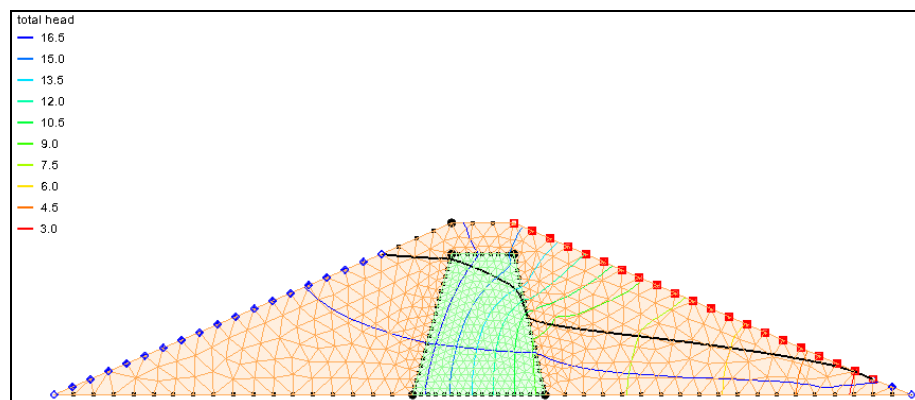



Figure 12 Contour lines after SEEP2D model run

7 Viewing the Solution

A plot of the flow net should now be visible. To better view the flow net, turn off the display of nodes and elements.

1. Click **Display Options**  to bring up the *Display Options* dialog.
2. Select “ 2D Mesh Data” from the list on the left.
3. On the *2D Mesh* tab, turn off *Nodes* and *Element edges* and turn on *Mesh boundary*.

4. Click **OK** to close the *Display Options* dialog.

Note that there are only a small number of flow lines (Figure 13). GMS determines the number of flow lines to display based on how closely spaced the equipotential lines are in one of the materials. By default, the interval is computed based on the Shell material.

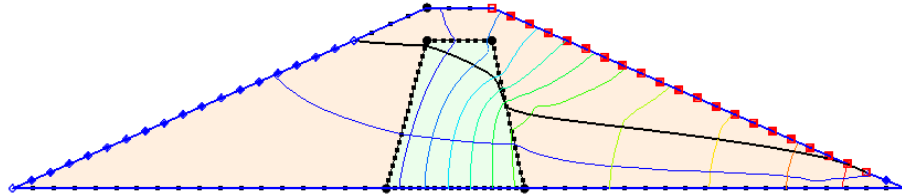



Figure 13 Less cluttered view with nodes and elements off and mesh on

To base the number of flow lines on the Core material, do the following:

1. Click **Display Options**  to bring up the *Display Options* dialog.
2. Select “ 2D Mesh Data” from the list on the left.
3. On the *SEEP2D* tab, select “Core” from the *Base Material* drop-down.
4. Turn on *Phreatic surface*.
5. Click **OK** to close the *Display Options* dialog.

Flow lines are now visible through the model as well as the phreatic surface (Figure 14).

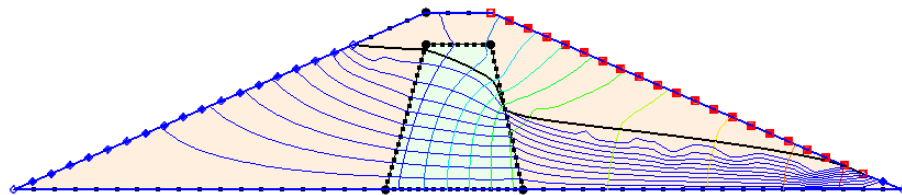

Figure 14 Flow lines and phreatic surface visible

8 Conclusion

This concludes the “SEEP2D – Earth Dam” tutorial. The following topics were discussed and demonstrated:

- SEEP2D can perform 2D unconfined flow modeling.
- SEEP2D problems can be set up quickly and easily using the conceptual model approach.
- Display a flow net and the phreatic surface in GMS.